

BlueGuard

hygienic fencing

DOUBLE HINGED DOOR

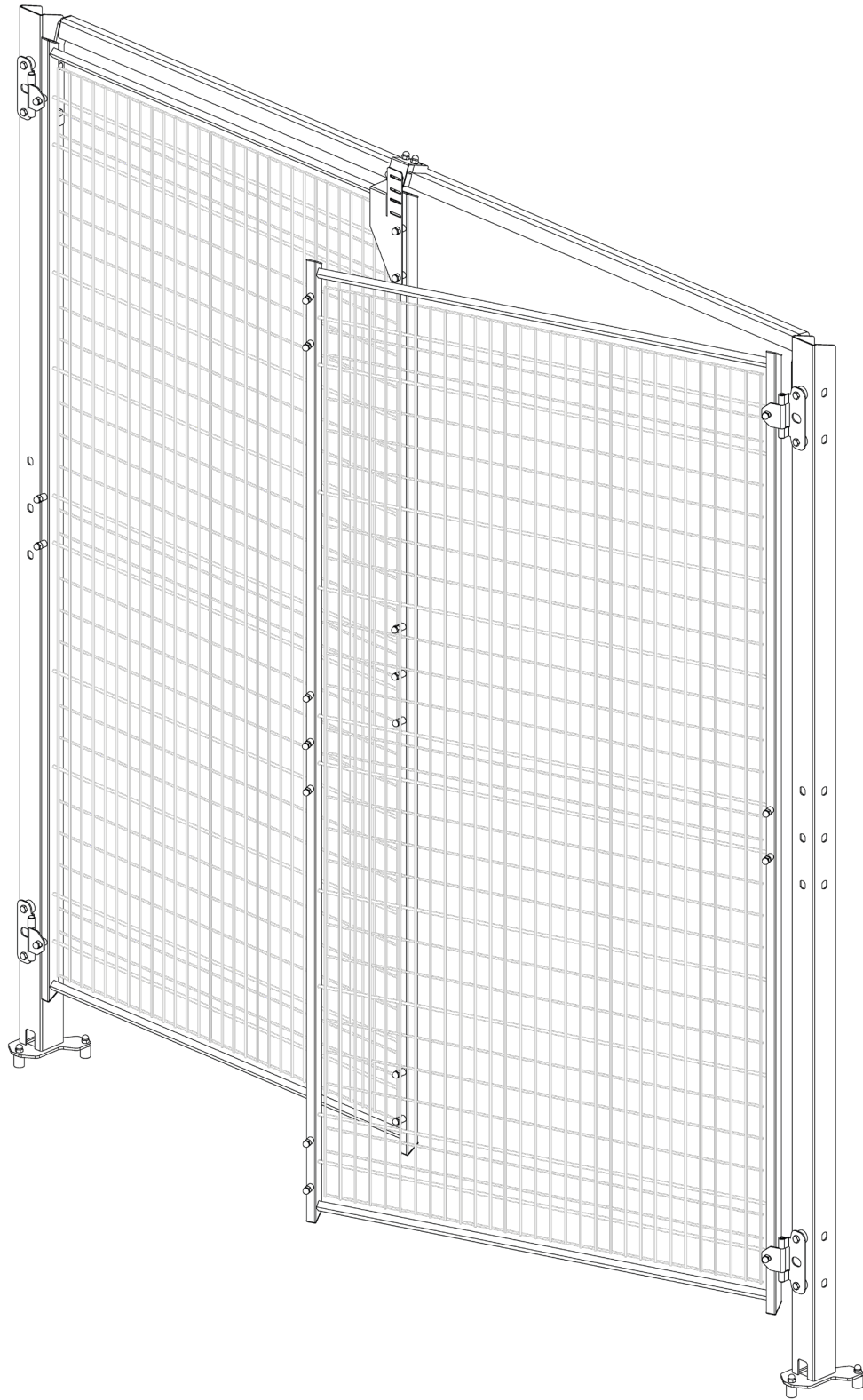
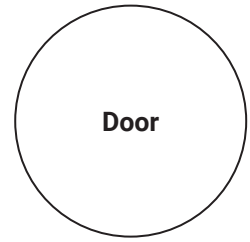

830234 / 830235
16501070 / 16501080



x 1

4SKBLGHIC

830042C-F01

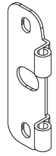

x 4

830042C-F02



x 4

830042C-F03

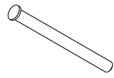

x 4

830073

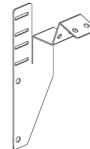

x 1

830075



x 1

830076

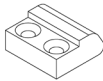

x 1

ISO 10642 M8 X 25



x 4

DIN 1587 M8



x 26

4KBLGAGGAC

830021



x 8

830026A



x 8

ISO 4017 M8 X 25



x 8

ISO 7093 Ø8 Ø24



x 8

830101 / 830043B
16501010 / 16501020

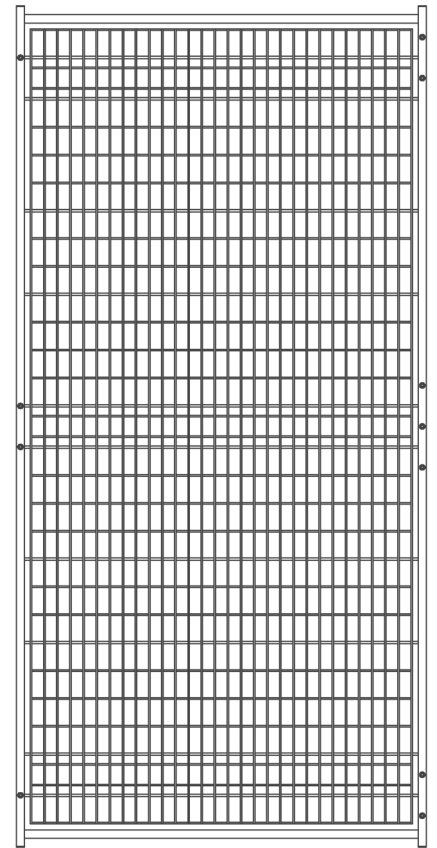

x 2

Tools

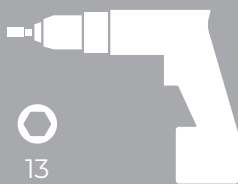

13



13

BlueGuard

DOUBLE HINGED DOOR

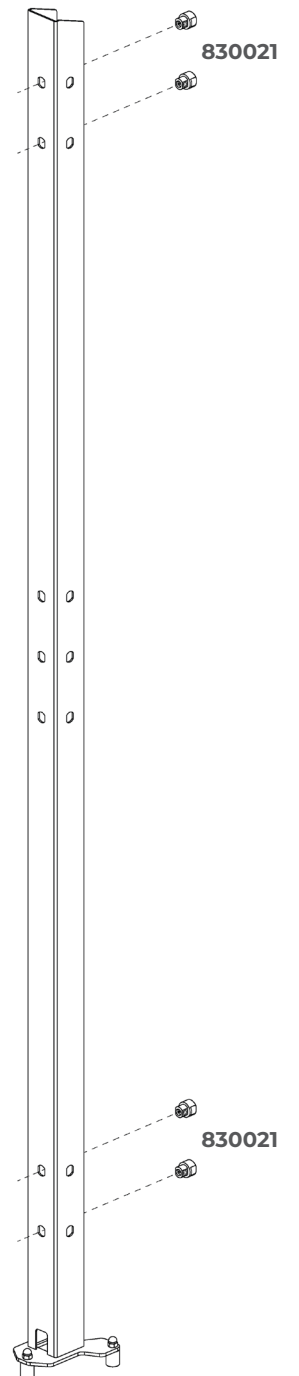
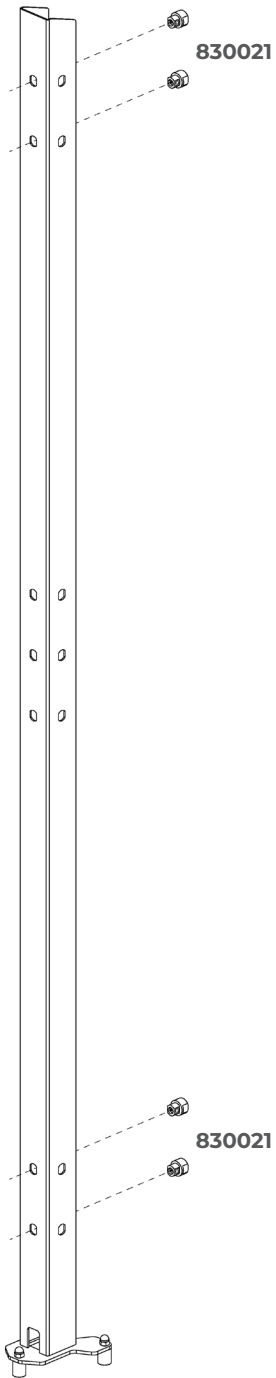

BlueGuard

DOUBLE HINGED DOOR

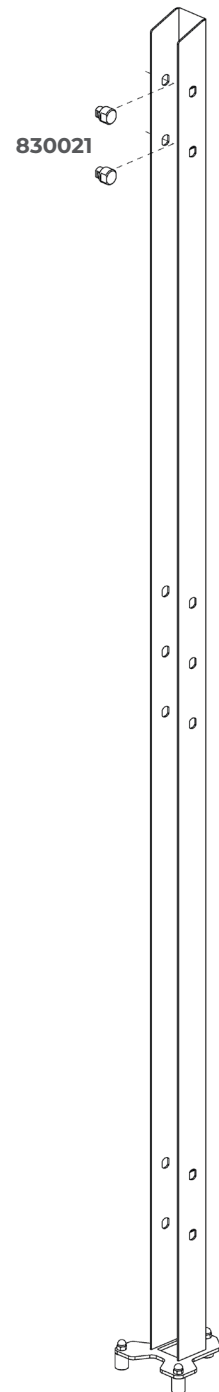
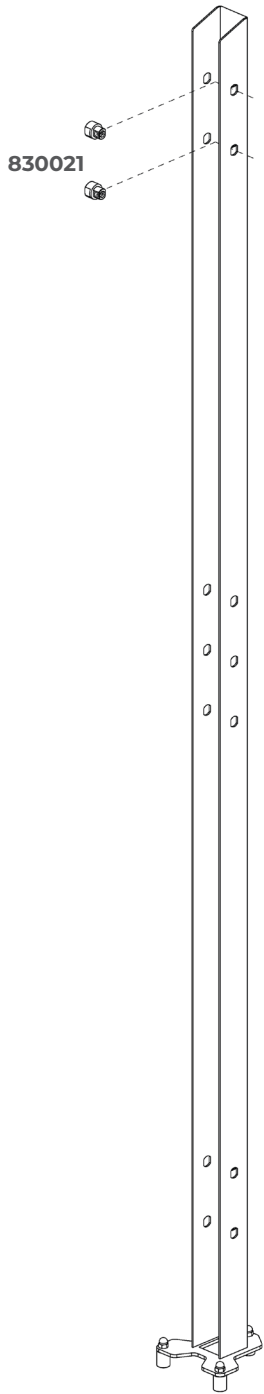

BlueGuard

DOUBLE HINGED DOOR

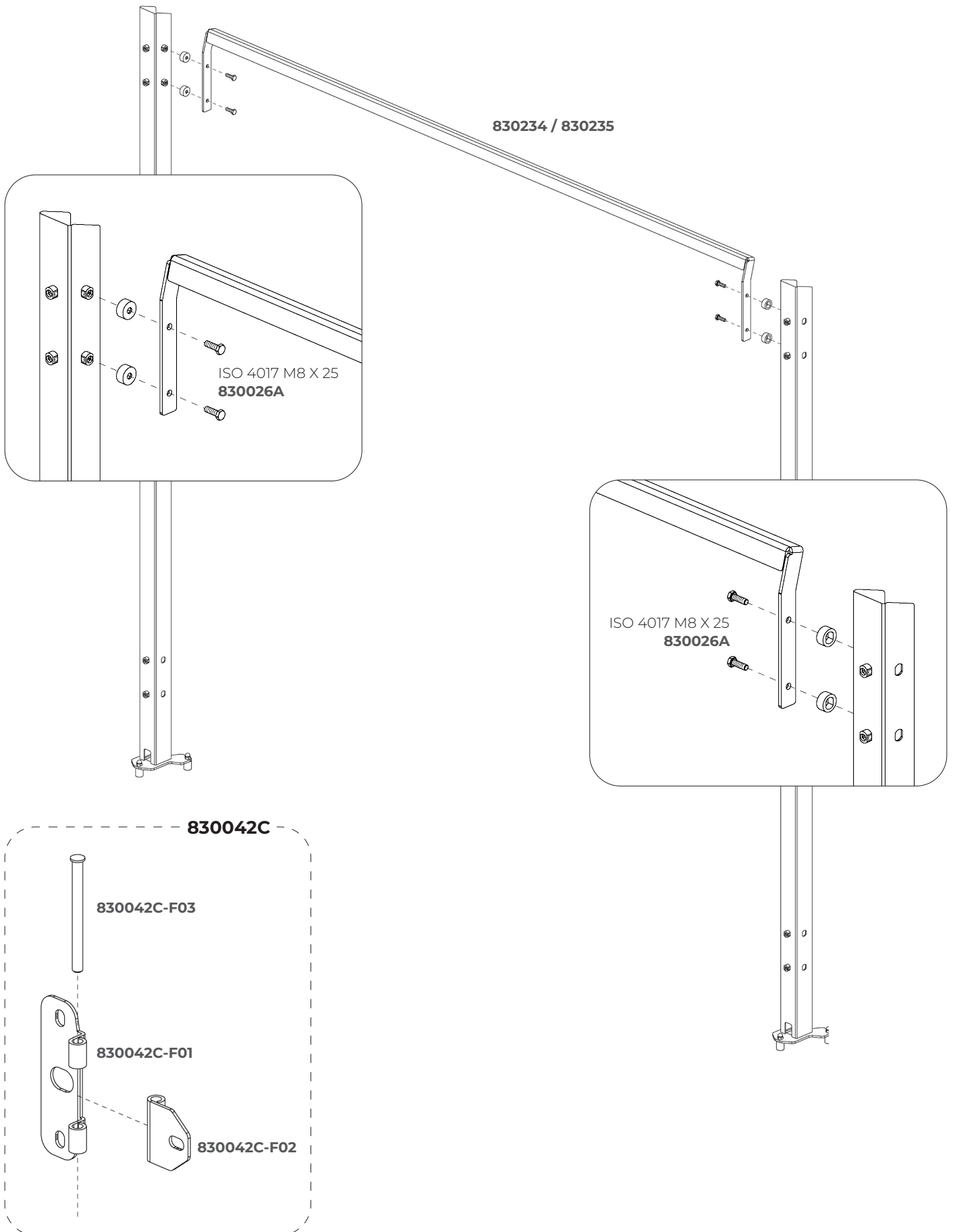

BlueGuard

DOUBLE HINGED DOOR

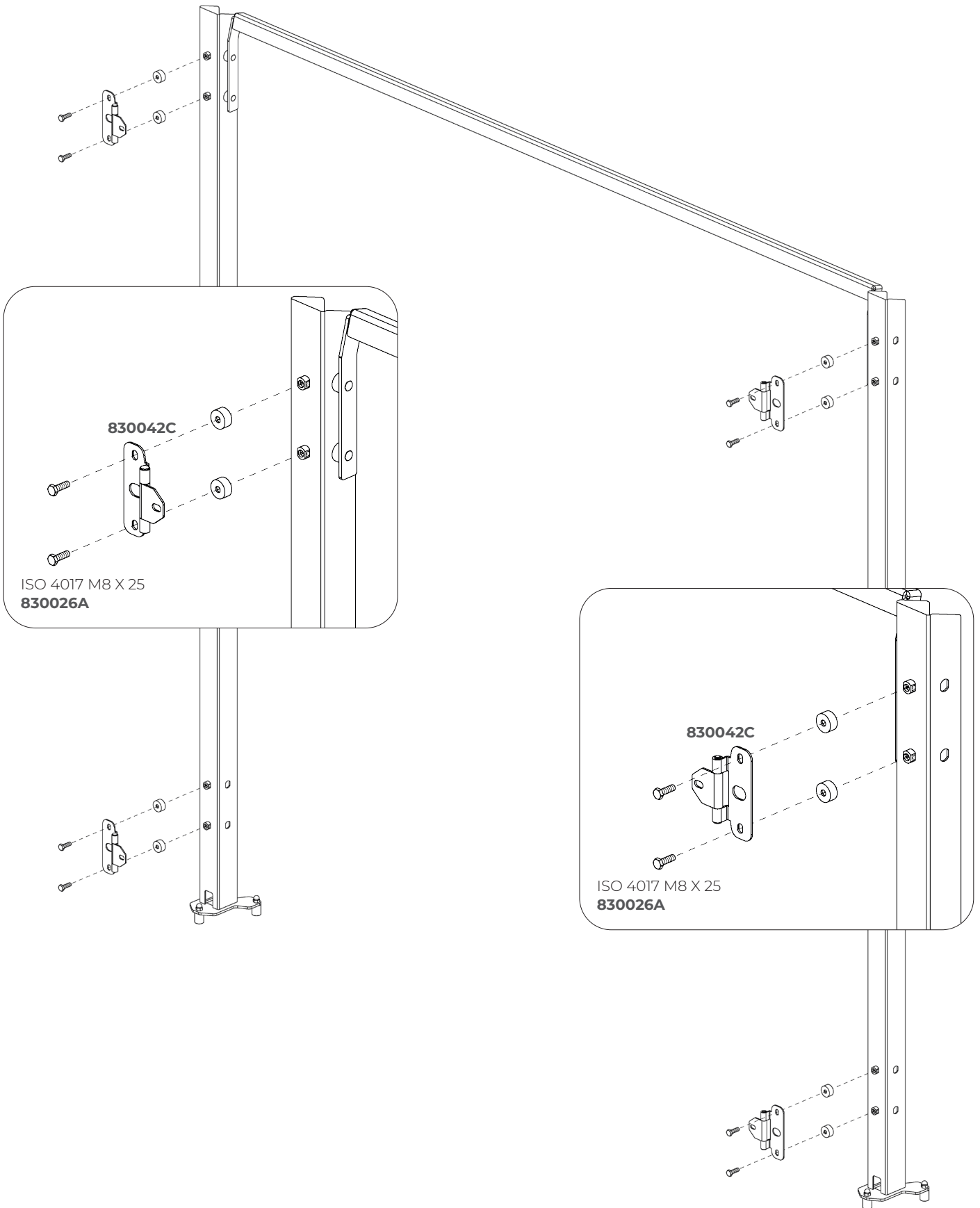

BlueGuard

DOUBLE HINGED DOOR

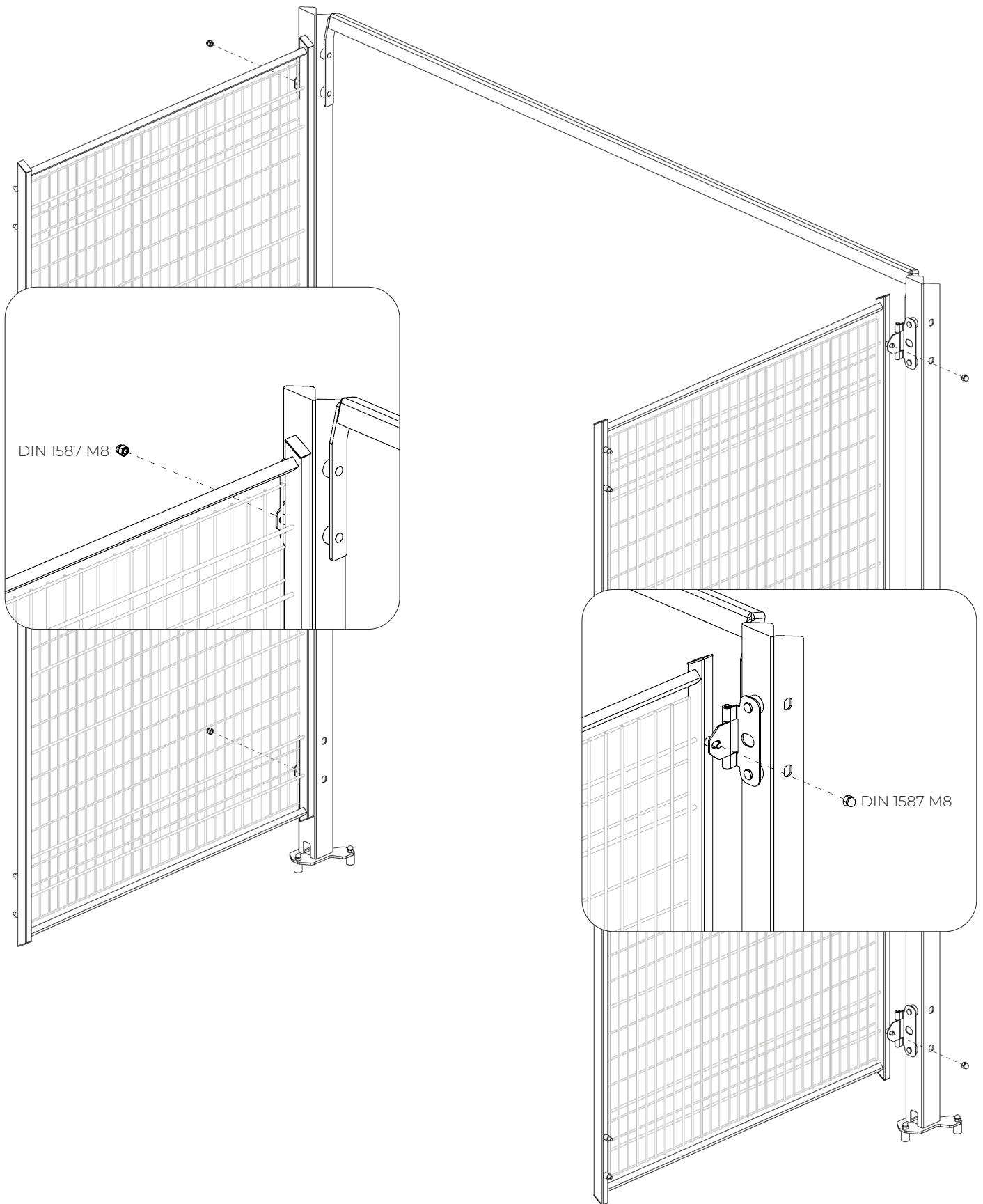

BlueGuard

DOUBLE HINGED DOOR

