

ASSEMBLY INSTRUCTION  
– JUST FOLLOW ME

# QUICKGUARD DOUBLE SLIDING DOOR

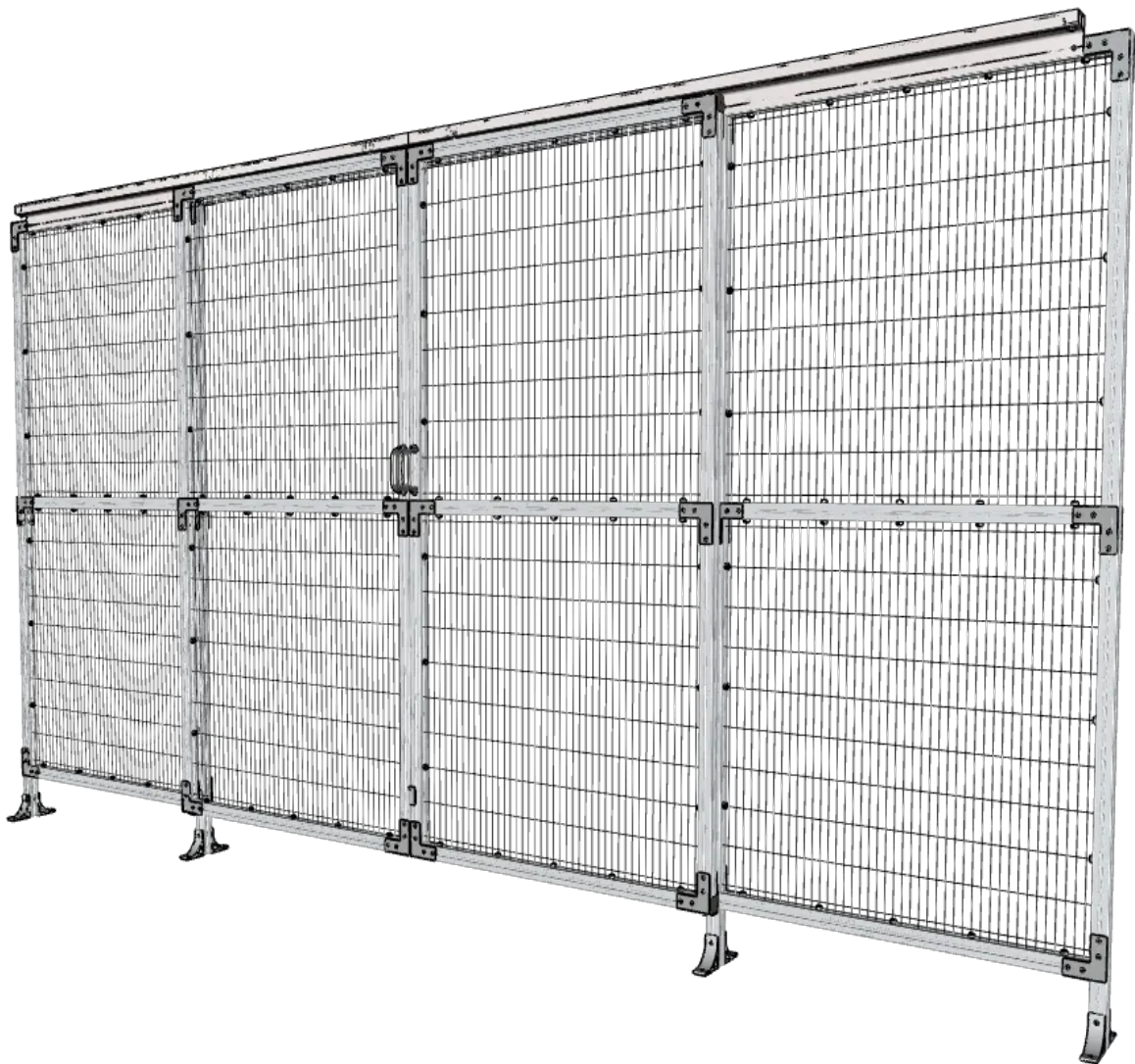

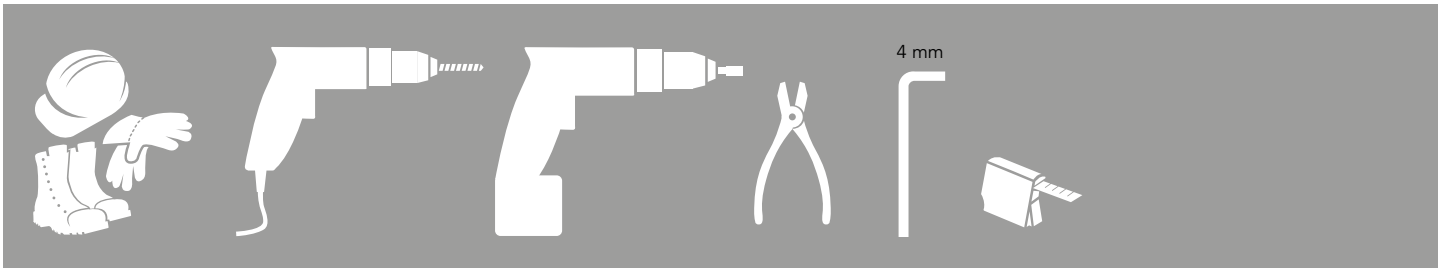

# QuickGuard Double Sliding Door

## Kit Sliding Door Alu System 15500062

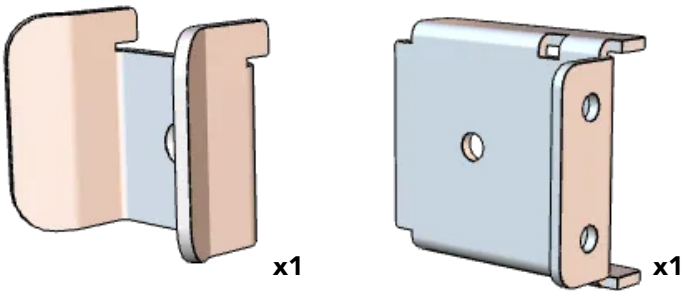
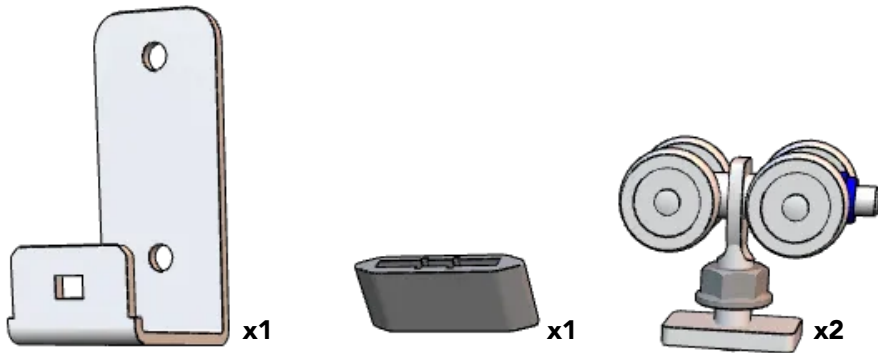

## Bag For Kit Sliding Door Alu System 88690062

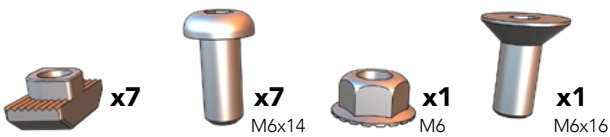

Art no: 88759431 ver. 001

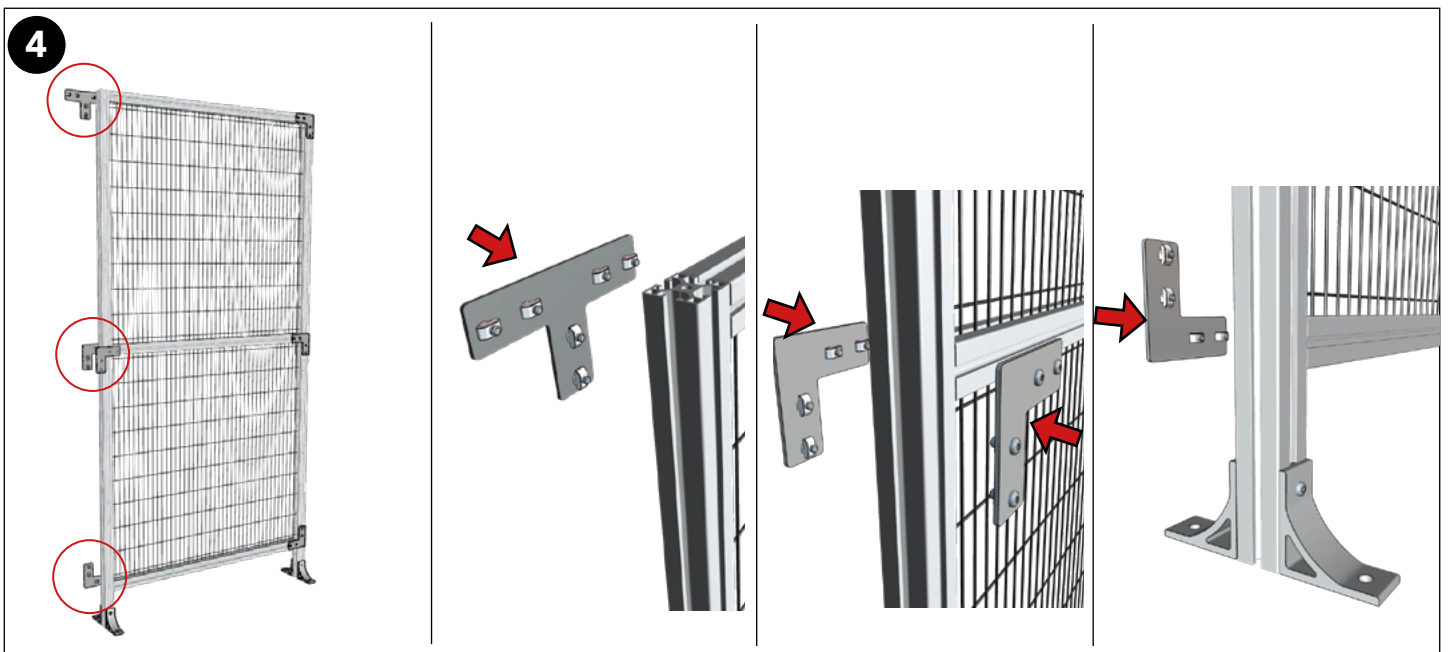
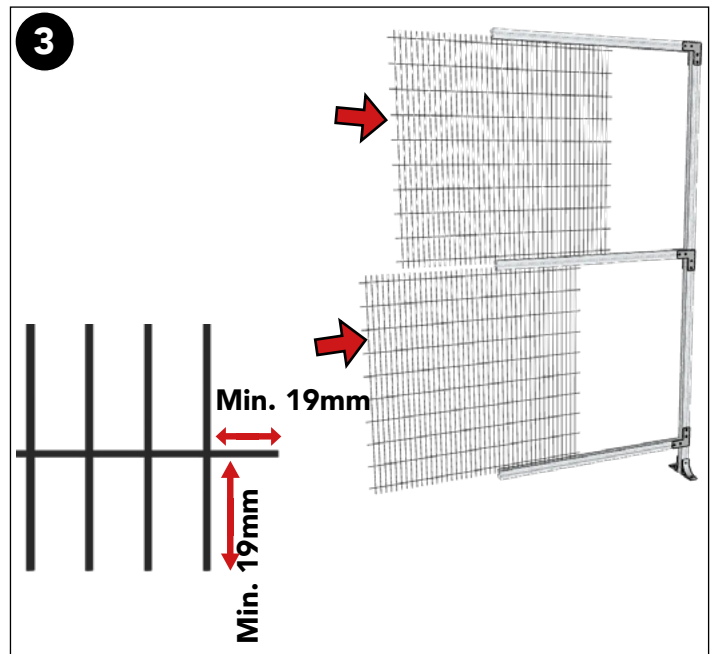
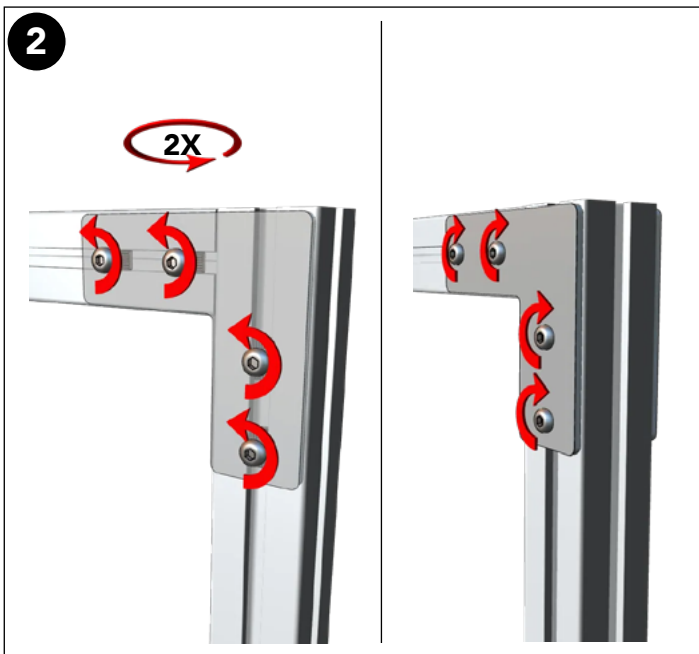
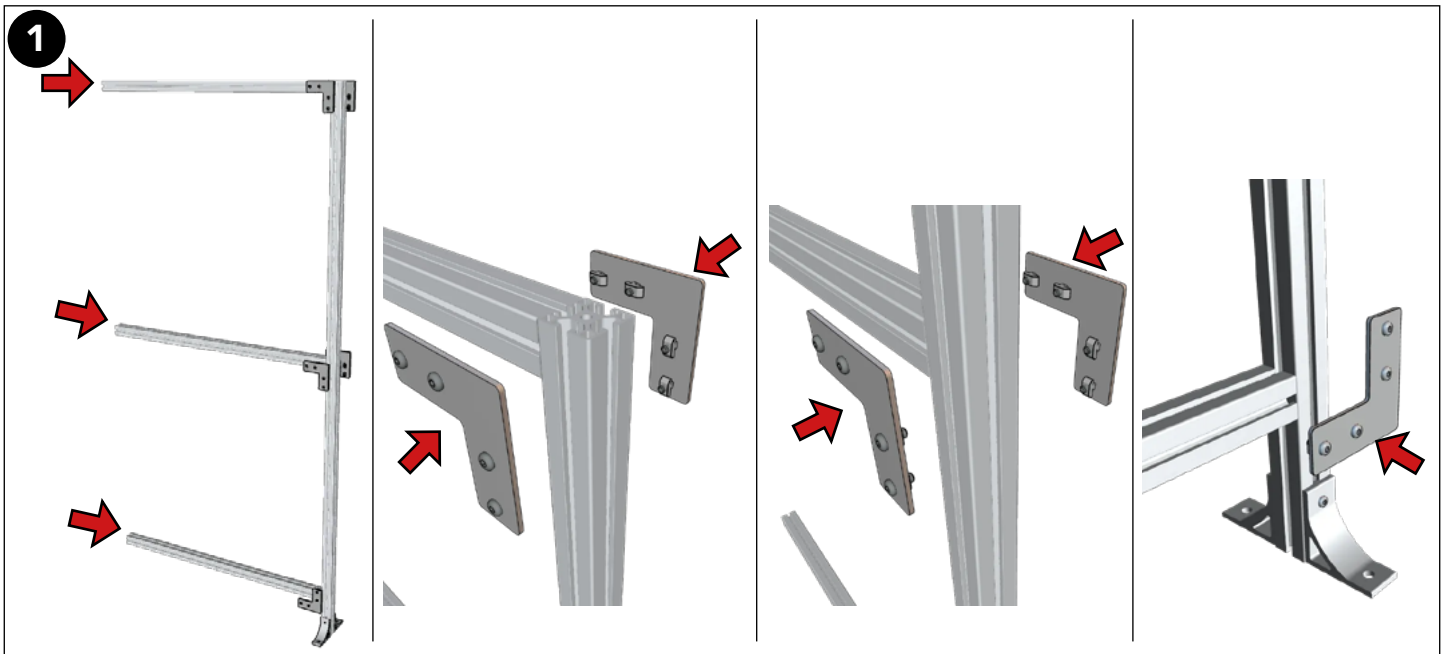

Art. no.: 88759431 ver.: 001

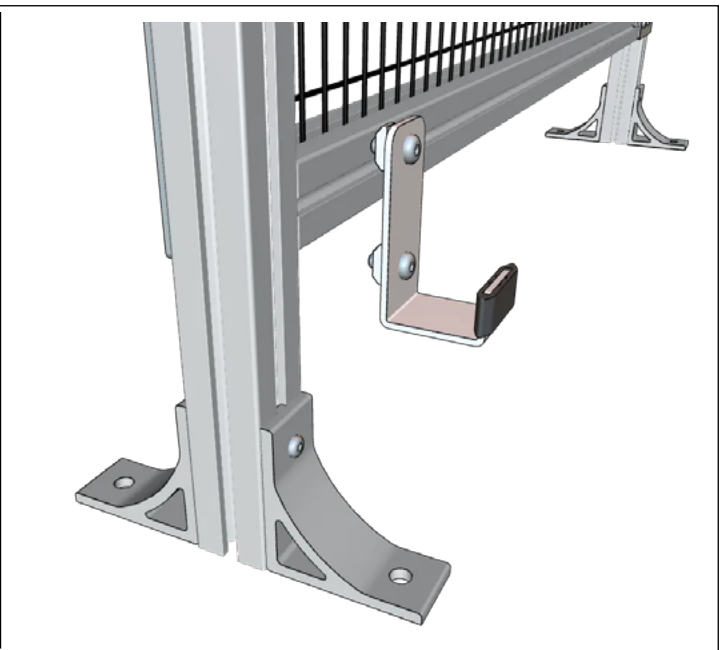
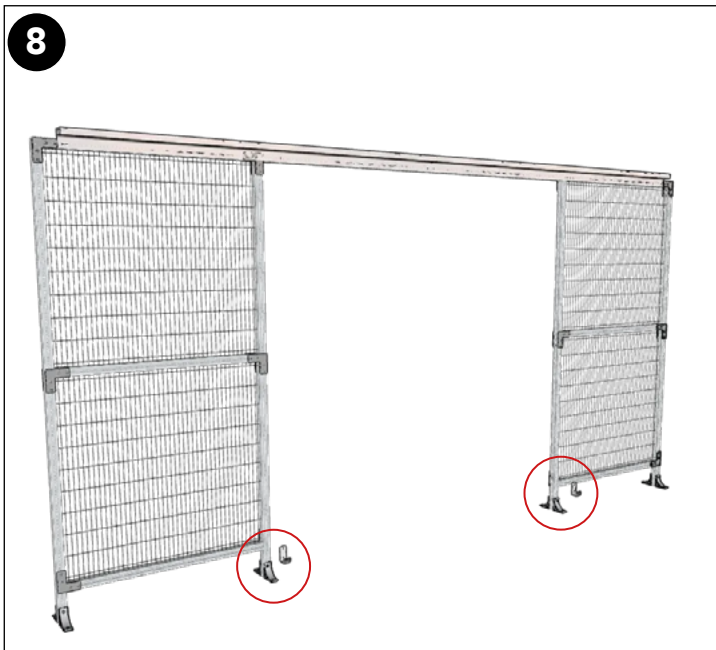
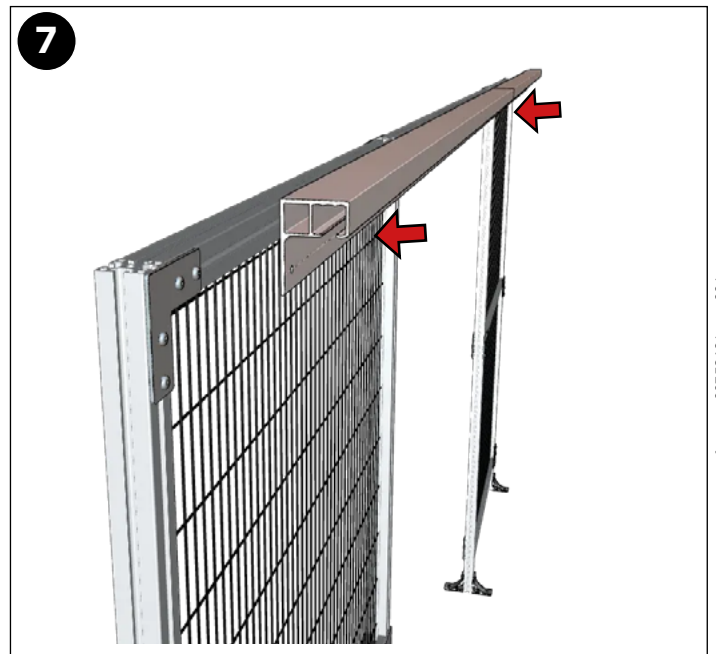
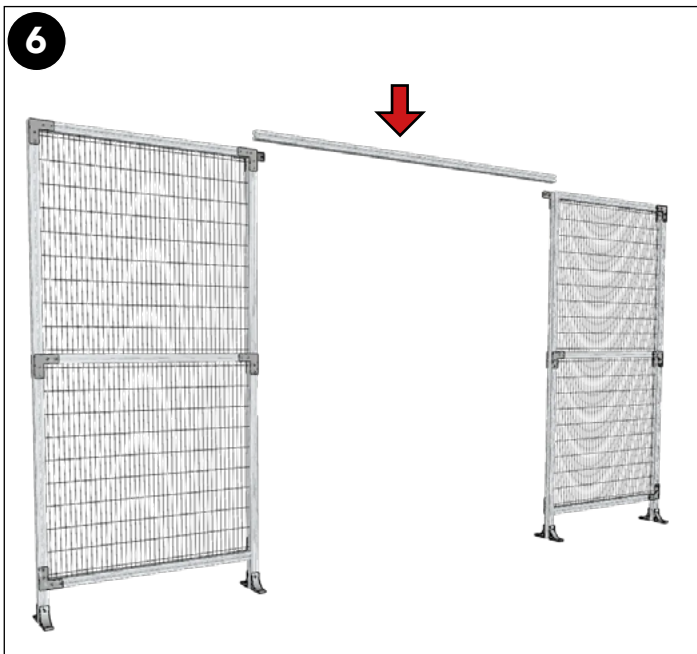
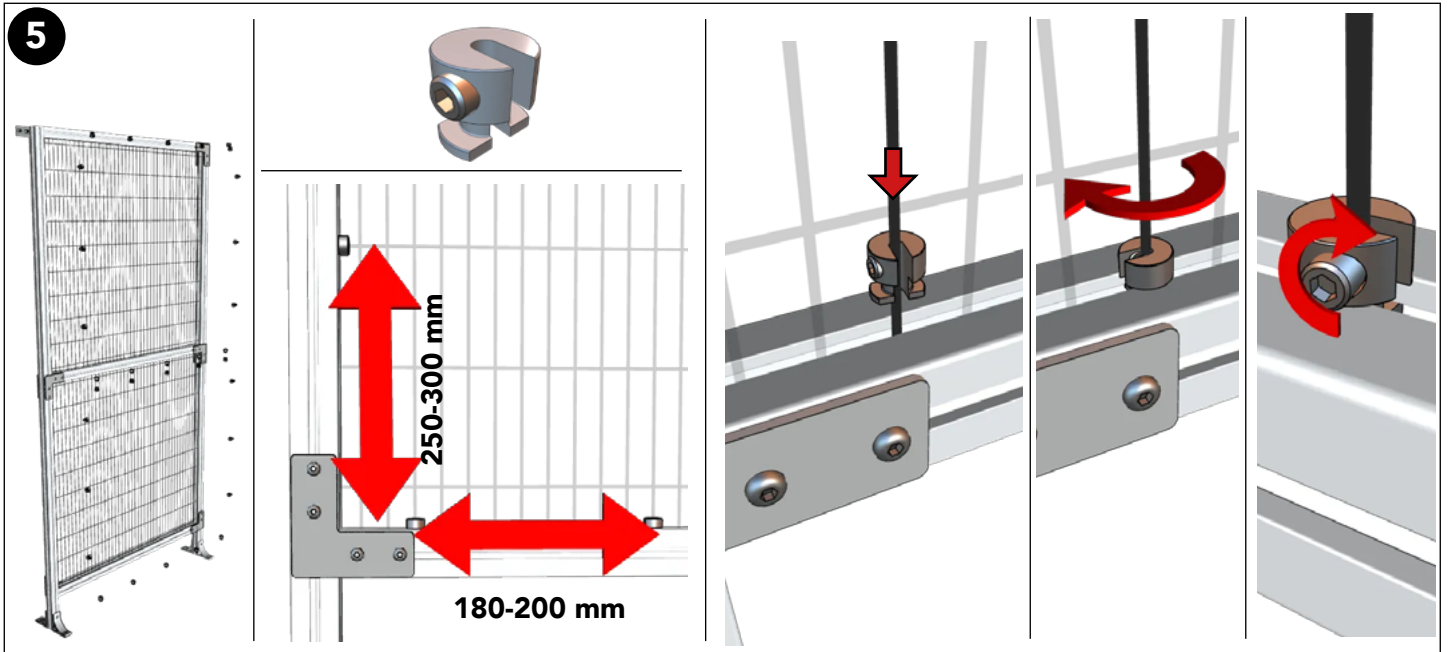

Art no: 88759431 ver. 001

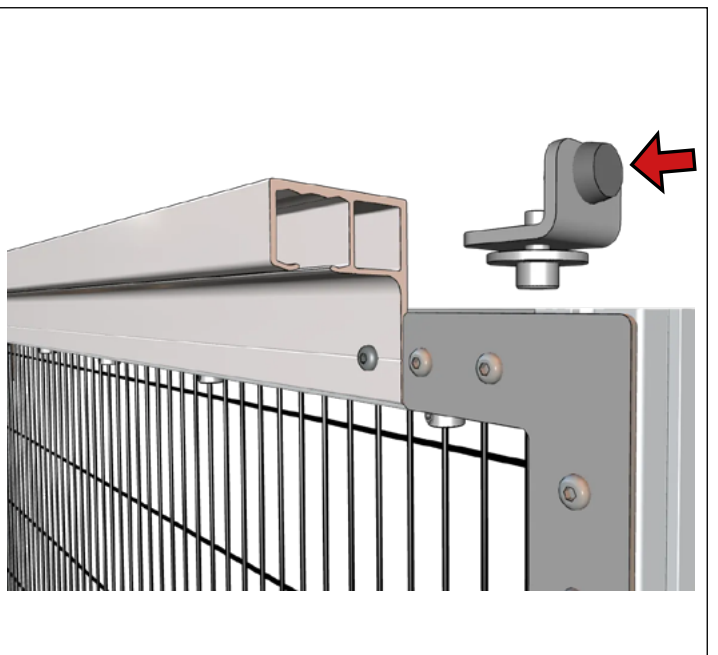
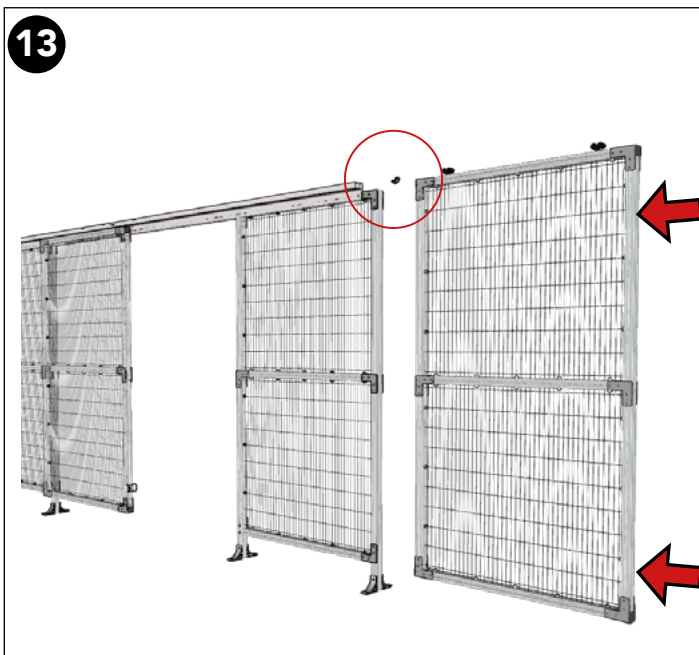
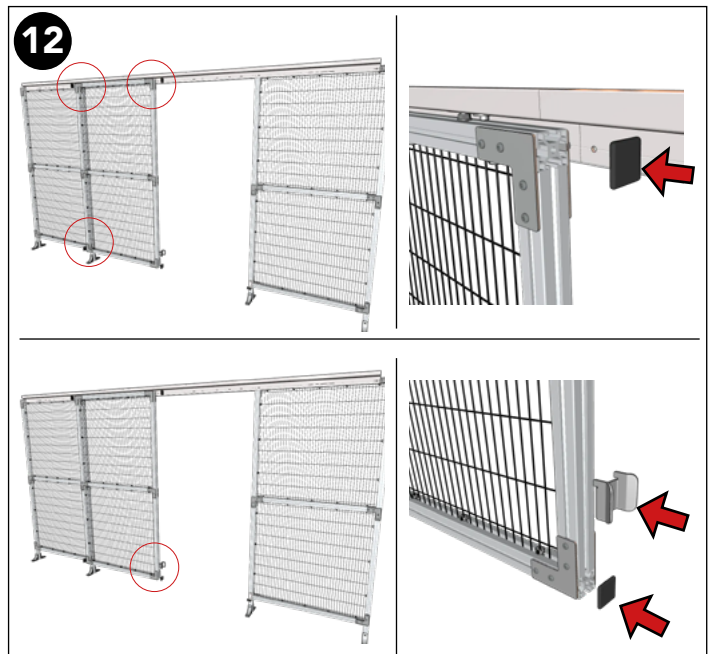
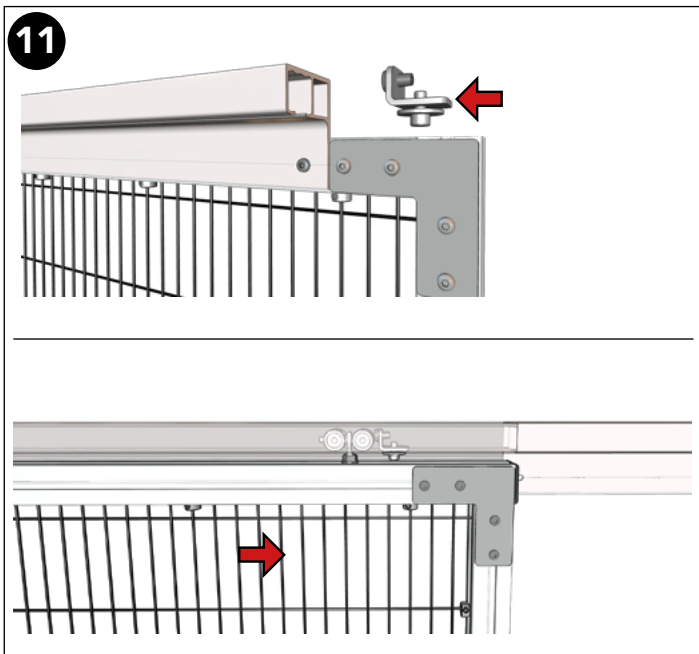
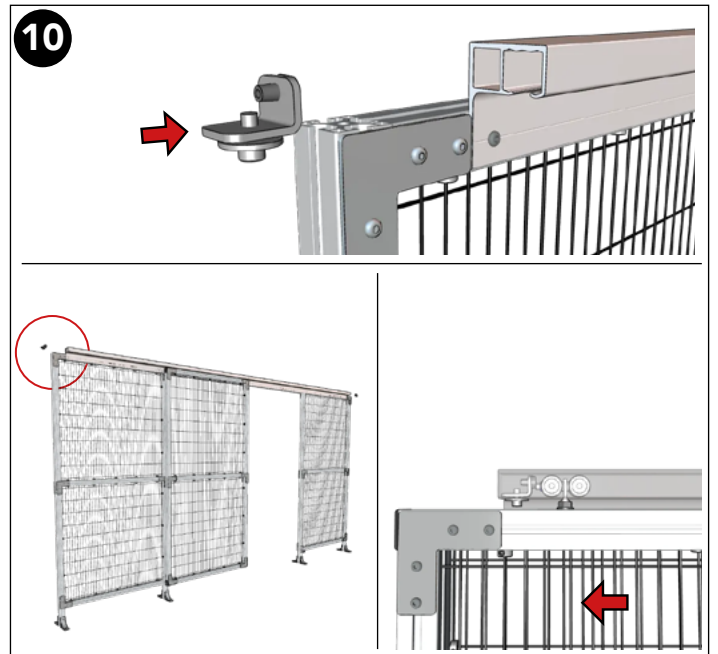
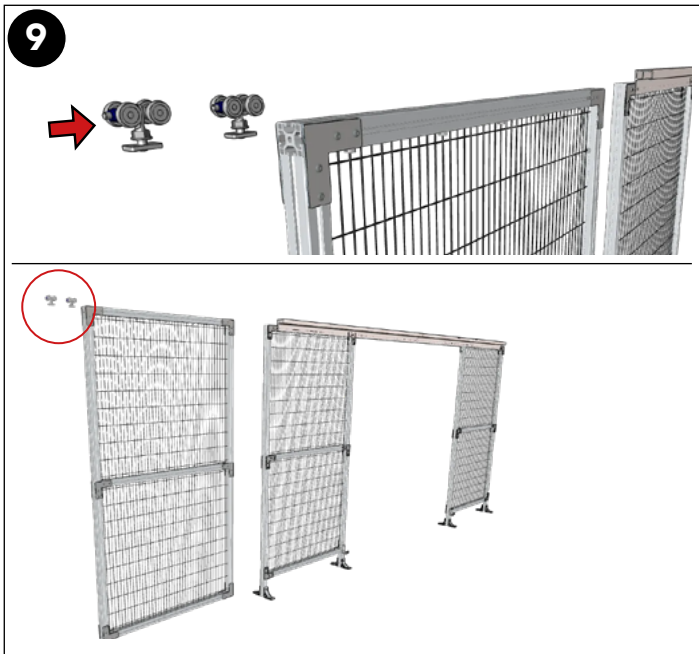

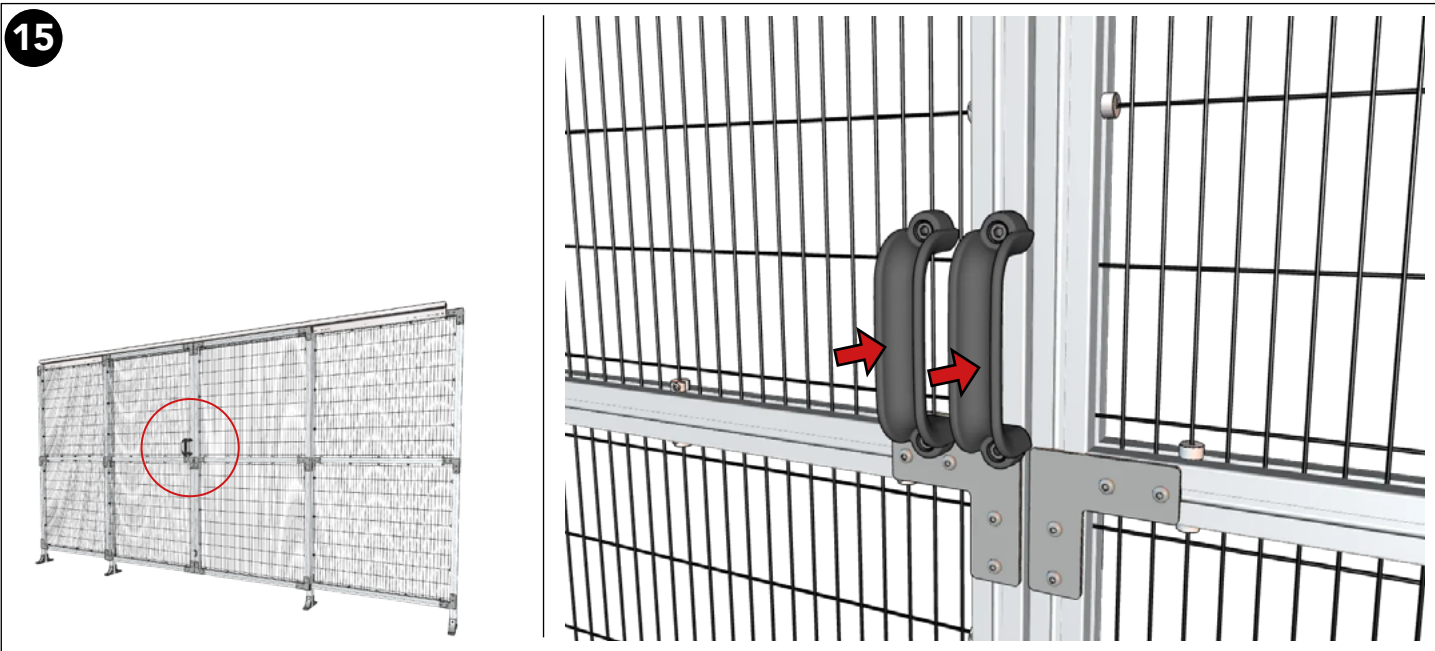
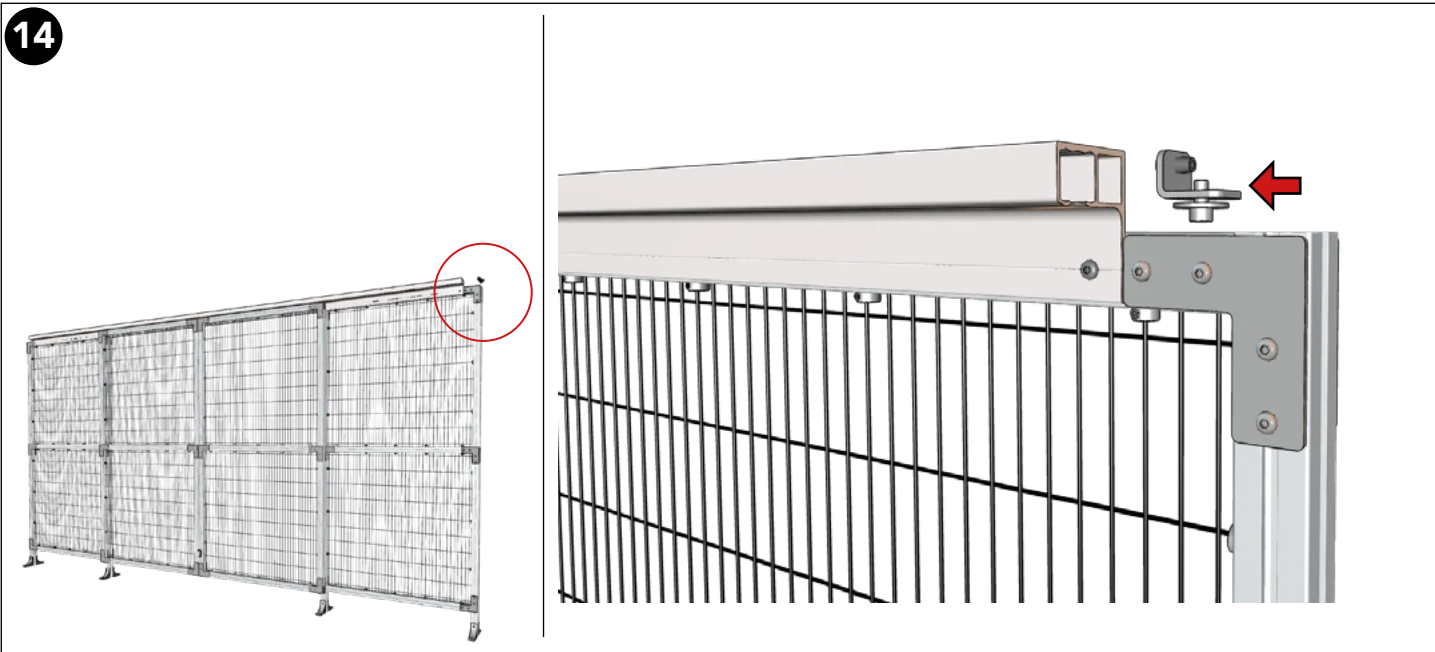

Art no: 88759431 ver. 001